

### Features

- One-piece toilets integrate the tank and bowl into a seamless, easy-to-clean design.
- Elongated bowl offers added room and comfort.
- 1.28 gallons per flush (gpf).
- 2-1/8-inch glazed trapway.
- Standard left-hand Polished Chrome trip lever included.
- Cachet® Quiet Close™ seat with Grip-Tight allows seat to close quietly and quickly unlatch from the toilet for easy removal and convenient cleaning.

### Technology

- Single-flush gravity uses the force of gravity and a precision-engineered tank, bowl, and trapway to create a strong siphon during flushing.
- AquaPiston canister allows water to flow into the bowl from all sides (360 degrees), increasing the power and effectiveness of the flush.
- Flush valve's 3:2 ratio harnesses the natural force of gravity and optimizes flush performance.
- Durable canister design has 90% less exposed seal material than a 3-inch flapper, for leak-free performance.
- Light-touch canister flush requires a lower actuation force than a flapper.
- AquaPiston canister flush valve optimizes flush performance and resists warping and deterioration.

### Installation

- Standard 12-inch rough-in.
- Supply line not included.

### Water Conservation & Rebates

- WaterSense® toilets meet strict EPA flushing guidelines, including using at least 20 percent less water than 1.6-gallon toilets.
- Eligible for consumer rebates in some municipalities.
- This product meets water savings requirements for Colorado SB 14-103.

### Recommended Accessories

K-75796 Cachet® Nightlight Quiet-Close™ Elongated Toilet Seat  
 K-8298 C3®-155 Elongated Cleansing Toilet Seat  
 K-5420 Low-Profile Bolt Caps  
 K-9466-L Left-Hand Trip Lever

### Components

Additional included component/s: Tank Cover, Trip Lever, Toilet Seat, Tank Accessory Pack, and Bolt Cap Accessory Pack.



### Codes/Standards









ASME A112.19.2/CSA B45.1  
 EPA WaterSense®

### KOHLER® One-Year Limited Warranty

See website for detailed warranty information.

### Available Color/Finishes

*Color tiles intended for reference only.*

Color	Code	Description
	0	White
	96	Biscuit
	47	Almond
	95	Ice™ Grey
	G9	Sandbar
	33	Mexican Sand™
	K4	Cashmere
	58	Thunder™ Grey
	7	Black Black™

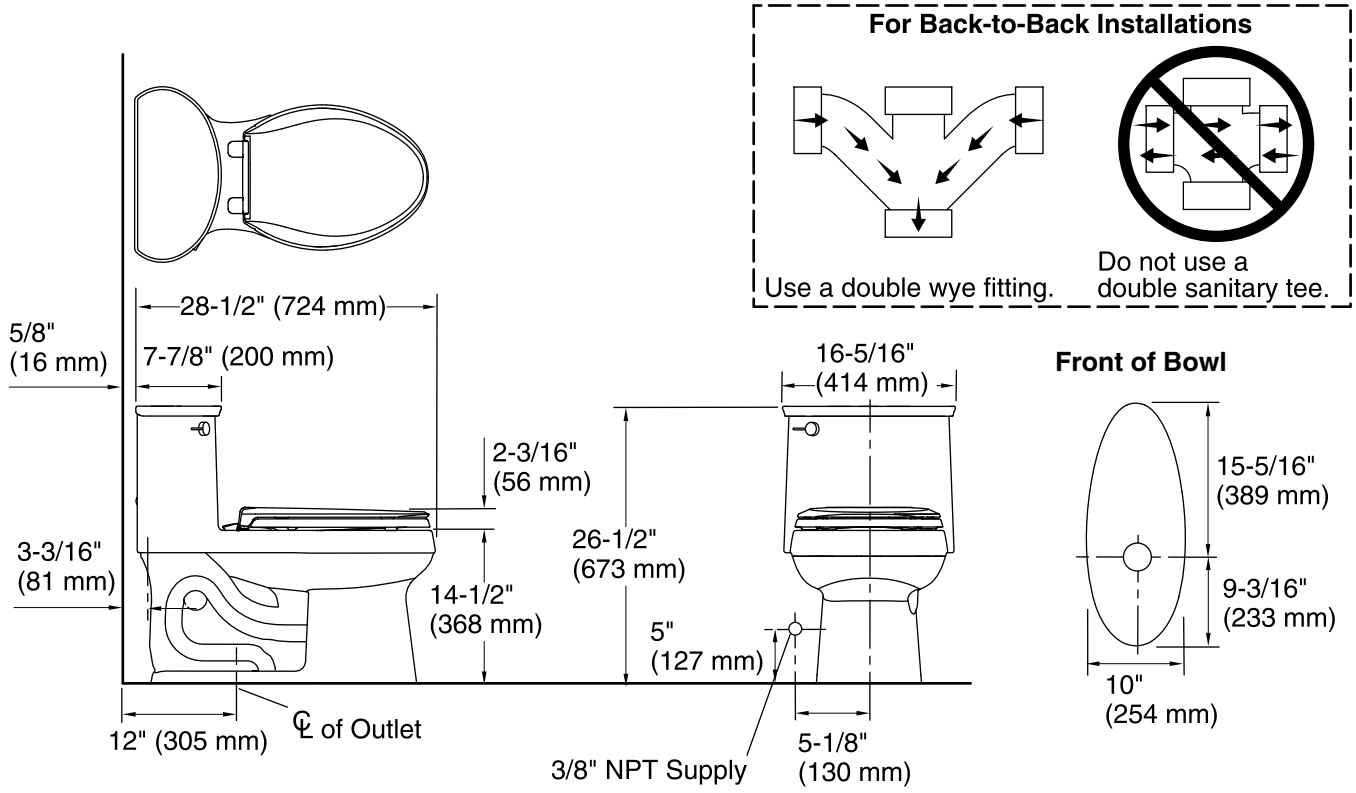

## Technical Information

All product dimensions are nominal.

Toilet type:	One-piece
Bowl shape:	Elongated front
Trap passageway:	2-1/8" (54 mm)
Water Consumption	
Full:	1.28 gpf (4.8 lpf)
Water surface size:	11-5/16" x 8" (287 mm x 203 mm)
Rim to water surface:	5-3/8" (137 mm)
Rough-in:	12
Seat-mounting holes:	5-1/2" (140 mm)

## Notes

Install this product according to the installation instructions.

For back-to-back toilet installations: Use only a 45° double wye fitting.